

Xp 3DXpert™

All-in-One Software Solution
for Metal Additive Manufacturing

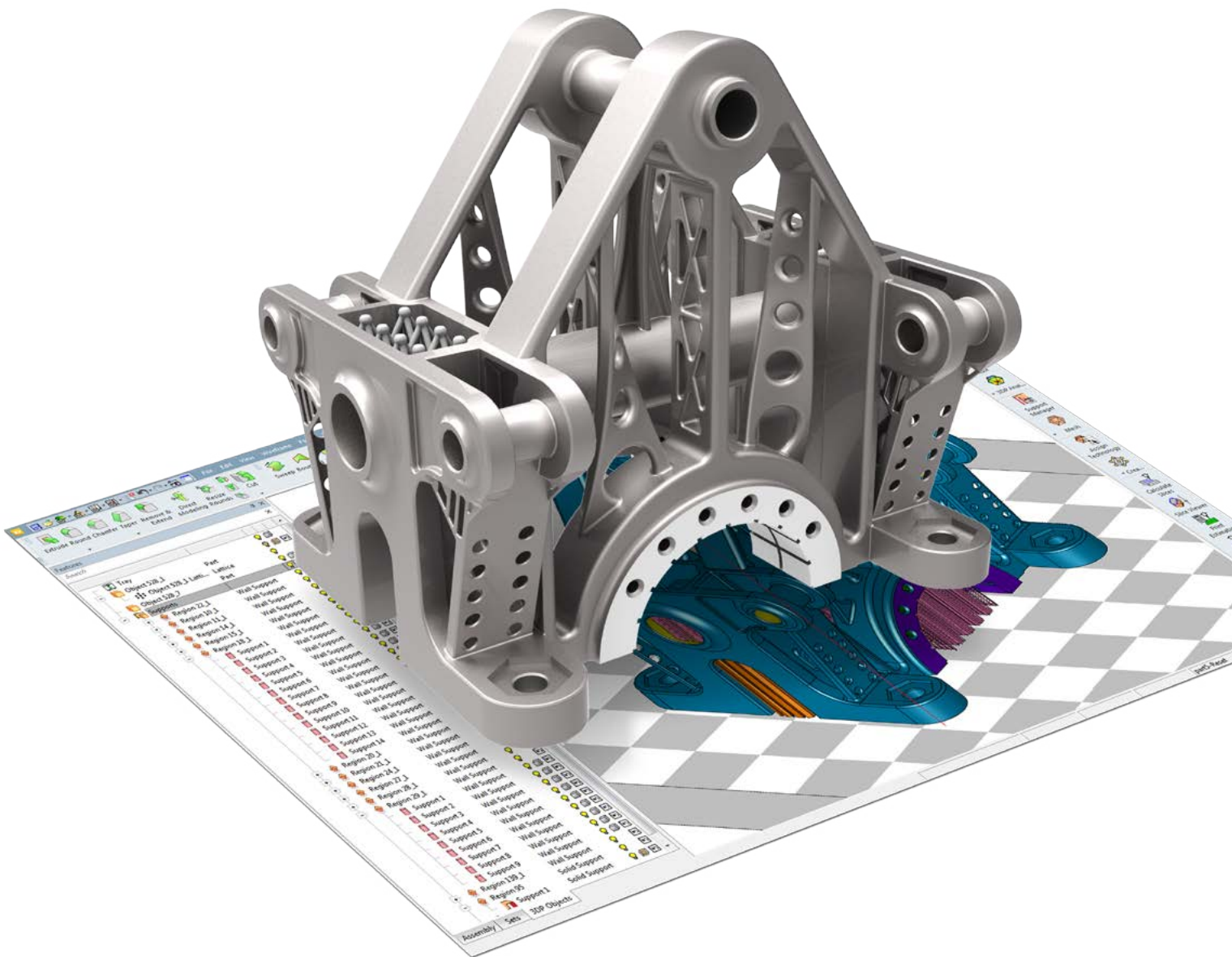



3DXpert™

What Makes 3DXpert™ Ideal for Metal Additive Manufacturing?

Specialized Requirements Call for Specialized Software

Metal Additive Manufacturing has unique requirements that are very different from 3D Printing of plastics and other materials. That is why you need software dedicated specifically to the needs of metal printing. 3DXpert™ was tailored to meet the specific challenges of Metal Additive Manufacturing. It helps you easily prepare and optimize parts for metal printing and enables you to print quality parts in record time.

A Single Integrated Solution for the Entire Process

3DXpert is a single, integrated solution that covers the entire metal additive manufacturing process. There is no longer a need for several different solutions to get the job done. 3DXpert offers everything you need – importing part data, optimizing the geometry and lattice creation, calculating the scan-path, arranging the build platform, sending it to the printer, and even machining of the final product when necessary – all in a single software solution.

Work with any Geometry for Greater Agility, Quality, and Speed

3DXpert brings a new era of part preparation for 3D printing. It allows you to seamlessly work with both B-rep (boundary representation, meaning solid or surfaces) and mesh triangulation formats (e.g. STL). This capability of 3DXpert eliminates the need to convert solid or surface data into mesh and improve data quality and integrity. Working in any format, you can save valuable time, and have greater flexibility to make changes to the model at any stage of the process, using history based parametric CAD tools.

Enjoy the Ultimate Combination of Automation and Full User Control

3DXpert provides the ideal mix of tools for automating repetitive tasks while allowing you to control each and every parameter and aspect of the entire design and manufacturing process. Get the most out of your printer using pre-defined best practice parameters for each printer, material, and print strategy or develop your own printing strategies with unprecedented control over scan-path calculation methods and parameters.

3DXpert Work Process – from design to manufacturing

3DXpert covers the entire spectrum of Additive Manufacturing. A single integrated software solution simplifies your workflow and removes any barriers to production. It gives you complete flexibility and control over design and manufacturing!

DESIGN

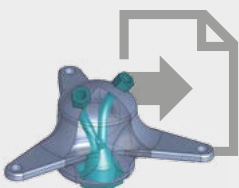

1 Import Data

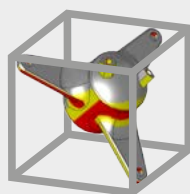

2 Position the Part

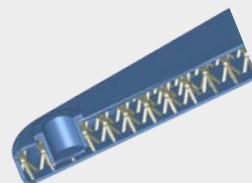

3 Optimize Structure

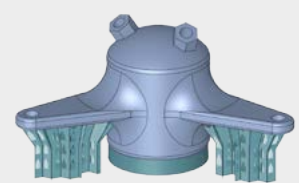

4 Create Supports

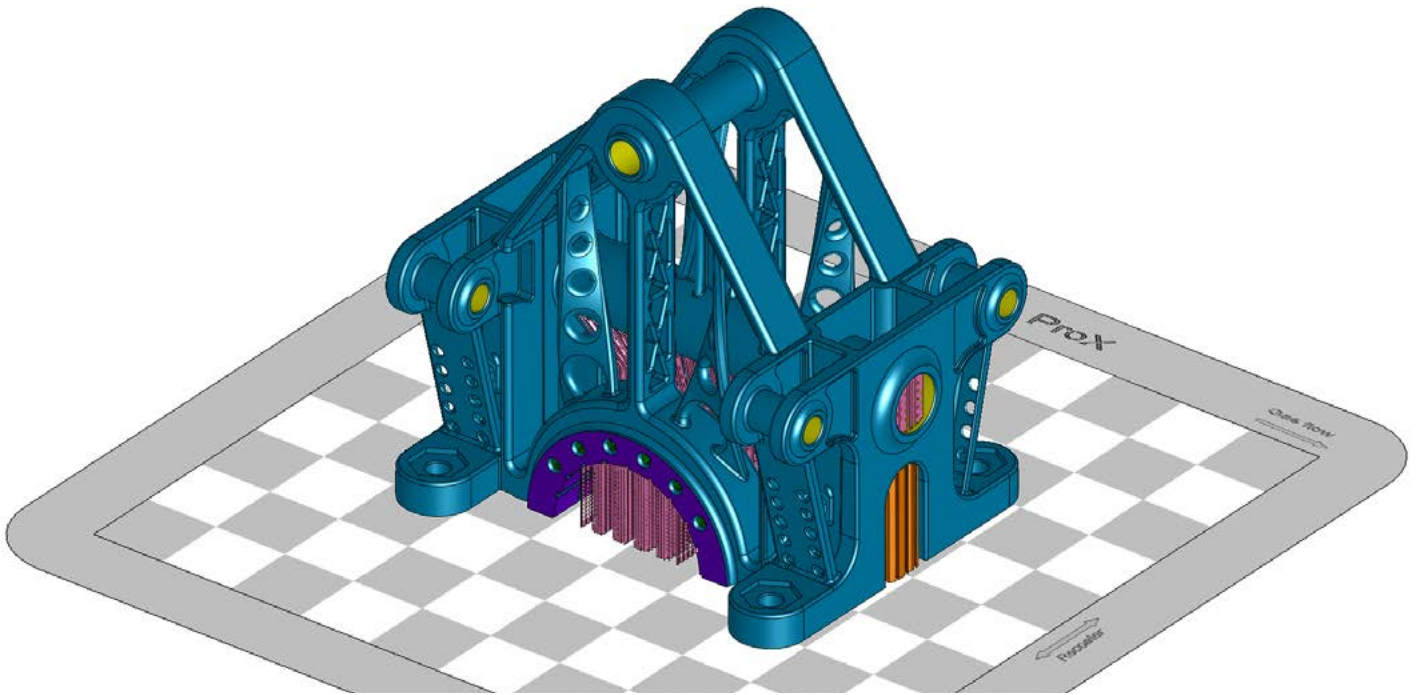

Optimize Printing Strategies to Shorten Print Time and Ensure Quality

3DXpert allows you to assign optimal print strategies to different zones and automatically fuse them into a single scan-path to minimize print time while maintaining part integrity. Unique and diverse printing strategies takes into account the design intent and part geometry to create an effective scan-path that addresses the challenges of 3D Metal Printing.

Partner with the 3D Experts

As a leading manufacturer of direct metal printers as well as pro-grade software for manufacturing, 3D Systems is uniquely positioned to deliver a complete solution that answers the needs of professional users, no matter what printer they use. When you need help, our global support team is here to ensure your success, lending unparalleled expertise from the industry leaders.

- Use an integrated solution to address all your metal 3D printing needs
- Prepare and optimize parts for printing, quickly and easily
- Print quality parts in record time

MANUFACTURE



5 Set Printing Strategies

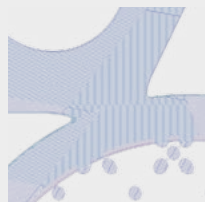

6 Calculate Scan-path

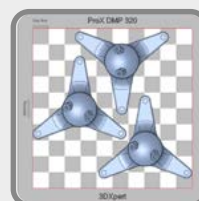

7 Arrange Build Platform and Print



8 Perform Post-printing Operation

Design

1 Import Data

IMPORT PART WHILE KEEPING CAD INTEGRITY

- Import data from all CAD formats (B-rep, DXF, IGES, STEP, VDA, Parasolid (including binary), SAT (ACIS), STL and SAB), native read formats including PMI data (such as AutoCAD, Autodesk Inventor, CATIA, Creo Elements/Pro, Siemens NX, SolidWorks and SolidEdge as well as virtually all Mesh formats).
- Take advantage of continued work with B-rep data (solids and surfaces). Reading B-rep geometry without downgrading to mesh maintains data integrity including analytic geometry, part topology and color coding. This allows preparing the part for printing using history based parametric features.
- Start working immediately with automated healing of both STL and B-rep geometry.

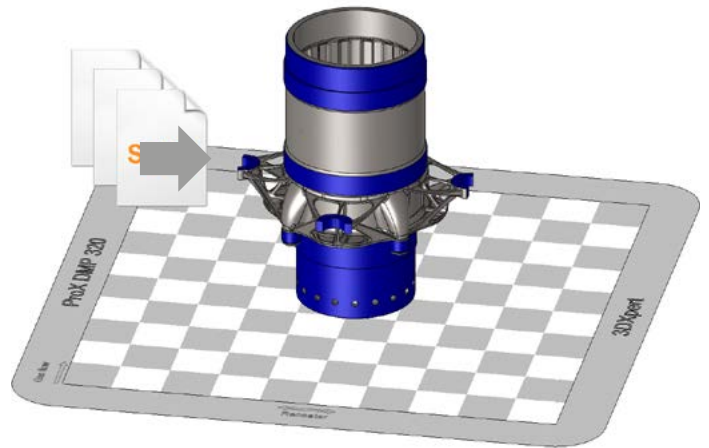

Part Preparation

MAKE ANY DESIGN WORK REQUIRED FOR OPTIMAL PRINTING

2 Position Geometry

- Position parts on the printer tray, with visualization of gas flow and Recoater/Roller directions.
- Set part orientation with real-time analysis of support and down-facing areas. Automated orientation optimization allows keeping tray area and supports to the minimum necessary.
- Apply scaling to compensate for part shrinkage during the build.
- Use a rich set of parametric and history-based hybrid (b-rep and mesh) CAD tools as well as advanced direct modeling tools to improve part printability and for post-build operations (e.g., close holes and add material for machining, modify geometry due to printability constraints).

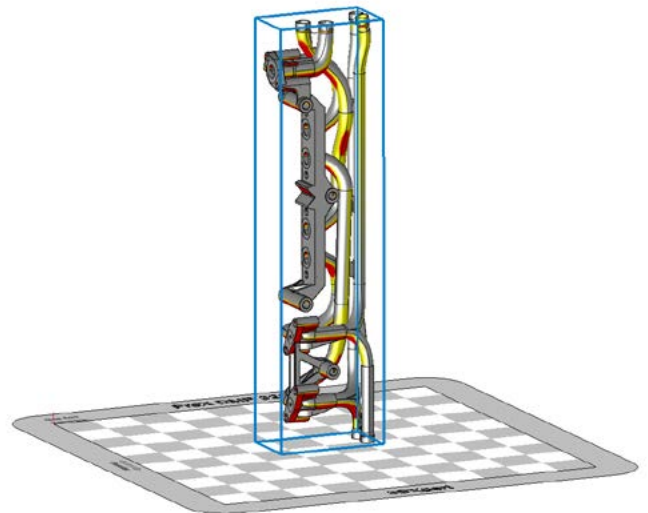

3 Optimize Structure

- Use Micro Lattice to save weight and material. A groundbreaking volume representation technology (V-Rep) allows for lightning-fast creation, editing, and visual manipulation of micro lattices, seamlessly combining the power of lattice structures with history-based parametric features.
- Optimize lattice structures by creating radial lattices to better fit circular parts, defining your own lattice cell structures, and applying variable lattice thickness based on FEA stress analysis.
- Import lattice structures designed by other systems.
- Apply surface lattice to medical parts using V-Rep technology. Add volumetric texture to the outer shell of implants and other medical models to create the required porosity.
- Hollow out parts using infills to reduce weight and material. Sweep based on a broad 2D pattern library to form internal walls within the part.
- Use a full set of CAD tools to mend the part (e.g. offset surfaces or holes size) and adjust it to the selected printer if required.

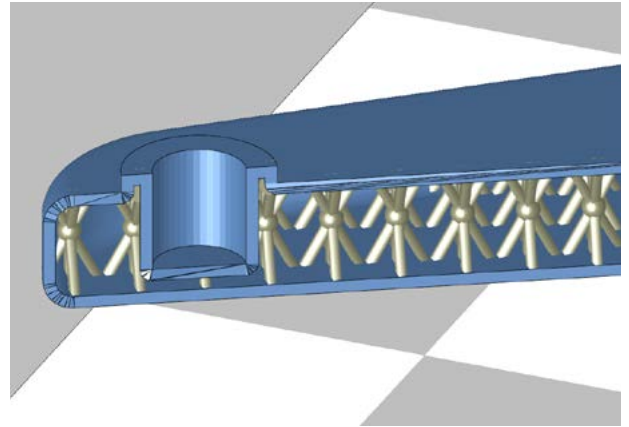

4 Design Supports

- Analyze the part to find regions that require supports, or manually define regions.
- Easily create supports of any type (wall, lattice, solid, cone and skirt supports). Use a rich tool set to fragmentize, tilt, and offset supports to simplify their removal and minimize material requirements.
- Define, save, and reuse your own templates for automating the creation of supports that fit your needs. Use higher level meta-templates to automate support creation for the entire part with just a single click.
- Eliminate the need to use supports in hard to reach areas. Define special printing strategies to ensure printing integrity without building supports.
- Perform quick analysis to identify areas with potential stress and adjust supports design to prevent part distortion.

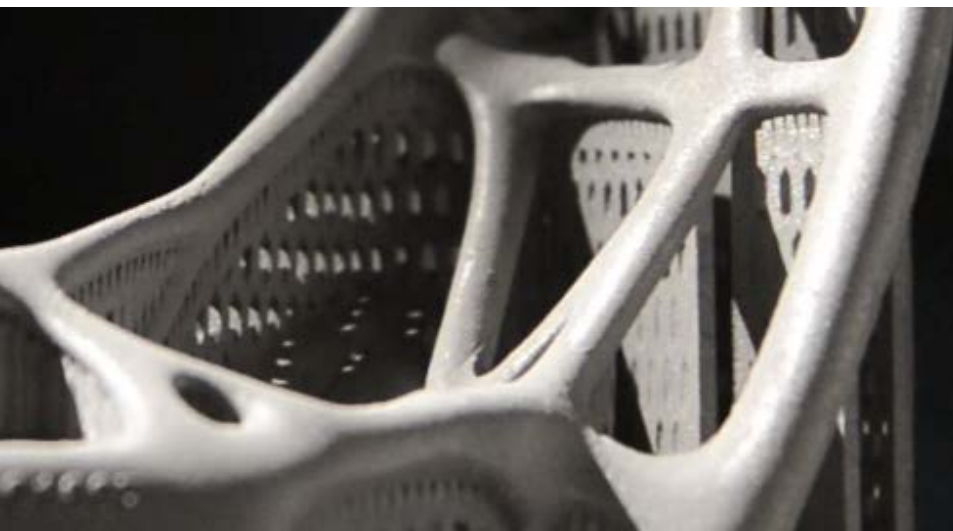
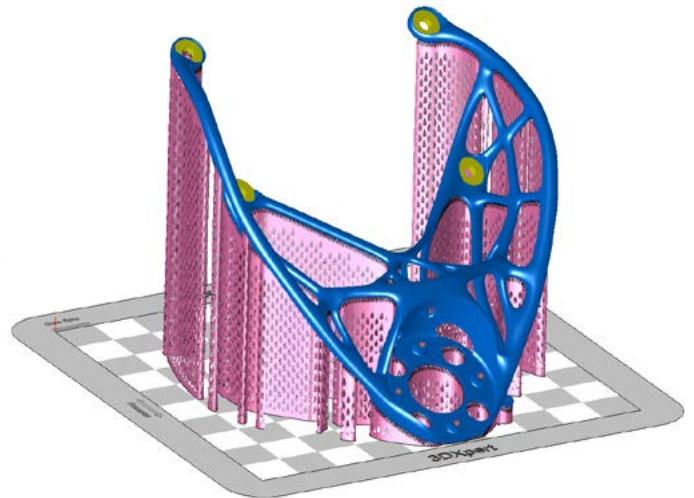

Manufacture

5 Optimize Printing Strategies

SHORTEN PRINTING TIME AND ENSURE HIGH SURFACE QUALITY

- Use Zoning technology to apply various print strategies to different areas of the part – reducing printing time and improving surface quality.
- Accelerate printing time with automated assignment of optimal print strategies to relevant objects (supports, lattices, etc.). Manually assign faster print strategies to internal volumes or zones that do not require high surface quality.
- Achieve better surface quality by assigning more accurate printing strategies to specific zones (e.g., small features, high surface quality, circular areas).
- Eliminate the need to divide the part into separate objects and avoid weak spots and lines – using automated fusion of zones with different print strategies to maintain part integrity.

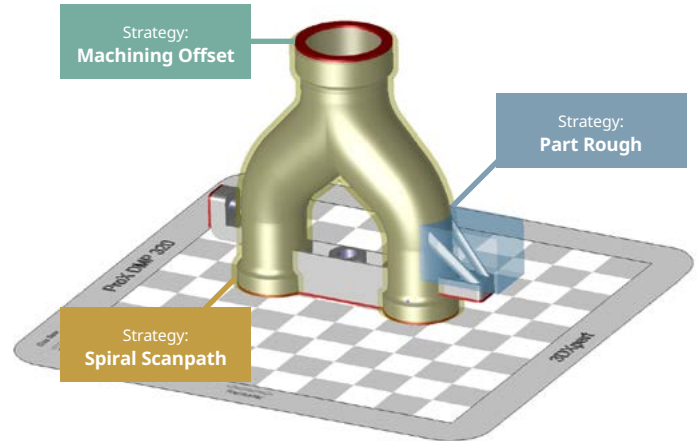

6 Calculate Scan-path

OPTIMIZE SLICING & HATCHING TO ENSURE REPEATABILITY AND QUALITY

- Enjoy intelligent scan path calculation based on a combination of zoning and part geometry.
- Validate the print process with a quick and accurate preview of the actual scan path for selected slices prior to fully calculating the entire part.
- Use the Scan Path Viewer to review the calculated contours and hatches.
- Shorten calculation time by offloading and distributing the calculation to additional computers.
- Get the most out of your printer using pre-defined best practice parameters for each machine, material, and print strategy, or develop your own printing strategies with unprecedented control over scan path calculation methods and parameters.

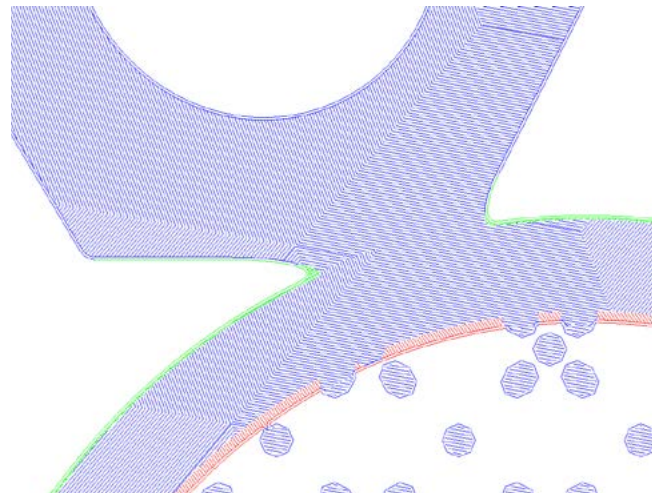

7 Arrange Build Platform & Print

USE THE OPERATOR EDITION TO EASILY POSITION PARTS ON THE TRAY AND SEND THEM TO PRINT

- Position the parts to be printed in any desired array on the build platform and combine all of their scan paths.
- Use a range of analysis tools to ensure all parts are ready for printing, enabling you to view the combined scan path and estimate print time, material consumption, and overall costs.
- Finally, send the optimal combined scan path to your printer.

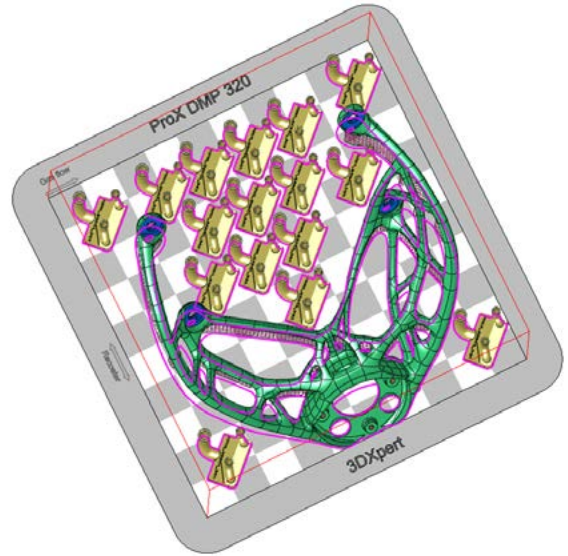

8 Perform Post-printing Operations

FINALIZE PART MANUFACTURING WITHIN THE SAME SYSTEM

- Use robust machining and drilling programming tools to remove supports, machine high-quality surface areas, and drill, tap or trim holes.
- Enjoy the benefits of using a single system by automatically receiving printing preparation data as stock (including support geometry, support region contours, and machining offset objects), and apply smart machining templates to them.

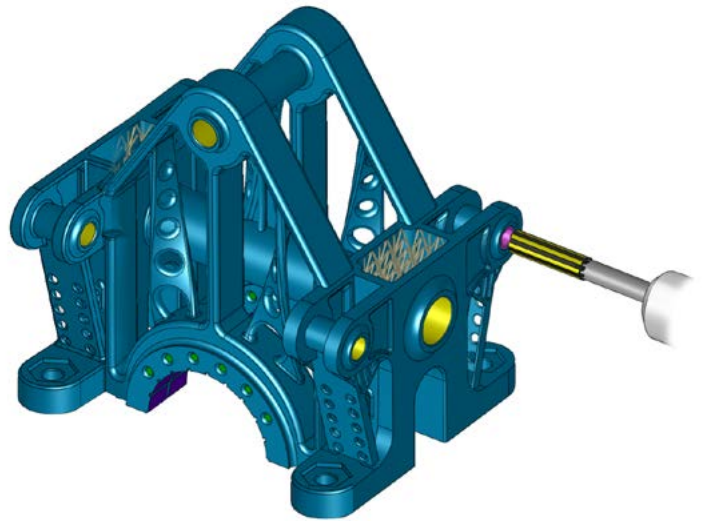



3DXpert™

All-in-One Software Solution for Metal Additive Manufacturing

“3DXpert is a game changer!

It simplifies our workflow and eliminates the need to work with multiple systems. The ability to work on a CAD geometry was one the main benefits we identified immediately. We can now handle large models without the need to convert them to STL and have the freedom to quickly design the supports to meet our specific requirements for additive manufacturing. In addition, having full control over the printing parameters with the ability to develop our own printing strategies, will take our productivity to a new level.”

- Mike McLean, 3D Printed Parts, Scarlett Inc.



3D Systems provides comprehensive 3D products and services, including 3D printers, print materials, on-demand parts services and digital design tools. Its ecosystem supports advanced applications from the product design shop to the factory floor to the operating room. As the originator of 3D printing and a shaper of future 3D solutions, 3D Systems has spent its 30 year history enabling professionals and companies to optimize their designs, transform their workflows, bring innovative products to market and drive new business models. Specifications subject to change without notice. 3D Systems, the 3D Systems Logo and 3DXpert Logo are registered trademarks of 3D Systems, Inc. All other trademarks are the property of their respective owners.